



CLUBMODELL:
„Taschentuchspender“

















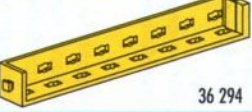









































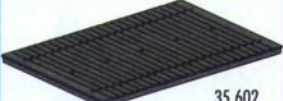

In Anlehnung an den weltgrößten fischertechnik Verpflegungsautomaten, den drei fischer-Azubis konstruiert haben (siehe FAN-CLUB-News 02/03) ist unser Modell diesmal der Taschentuchspender, ein Spender für Zellstofftaschentücher. Er besteht aus den Baukästen „E-Tec“ und „Creative Box 1000“.

Ein 20-Cent-Stück ist nötig, um ein Päckchen „ziehen“ zu können: der Münzprüfer sorgt dafür, dass andere Münzen nicht funktionieren. Dies geht über einen Taster und eine Lichtschranke. Erst wenn beide Sensoren aktiviert wurden (die Münze drückt den Taster während die Lichtschranke prüft, ob das Geldstück tatsächlich durchgefallen ist), fährt ein Motor das Päckchen ins Ausgabefach.

Natürlich kannst Du das Modell mit ein paar zusätzlichen oder anderen Teilen auch für Schokoriegel usw. umrüsten. Sei kreativ. Wir wünschen Dir viel Spass und Erfolg als Automatenbetreiber!



Einzelteilübersicht

 108 227	1 x	 32 330	2 x	 36 293	2 x	 37 869	2 x
 31 010	2 x	 32 850	2 x	 36 294	6 x	 38 216	3 x
 31 011	2 x	 32 854	2 x	 36 297	5 x	 38 240	8 x
 31 060	12 x	 32 859	1 x	 36 298	3 x	 38 241	10 x
 31 061	6 x	 32 879	30 x	 36 299	6 x	 38 242	1 x
 31 336	16 x	 32 881	20 x	 36 323	2 x	 38 244	2 x
 31 337	16 x	 32 882	12 x	 36 532	2 x	 38 245	2 x
 31 360	1 x	 32 958	1 x	 36 920	2 x	 38 246	5 x
 31 426	2 x	 35 049	5 x	 36 921	4 x	 38 248	2 x
 31 436	2 x	 35 053	7 x	 36 950	3 x	 38 259	1 x
 31 981	2 x	 35 076	2 x	 37 237	8 x	 38 423	4 x
 31 982	10 x	 35 084	1 x	 37 238	4 x	 38 428	6 x
 32 064	7 x	 35 129	2 x	 37 272	1 x	 38 464	2 x
 32 233	1 x	 35 602	1 x	 37 351	3 x		
 32 263	1 x	 35 969	5 x	 37 468	5 x		
 32 293	1 x	 36 134	1 x	 37 783	3 x		

Taschentuchspender

1

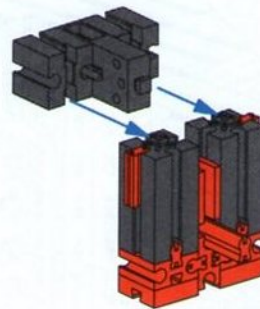

2

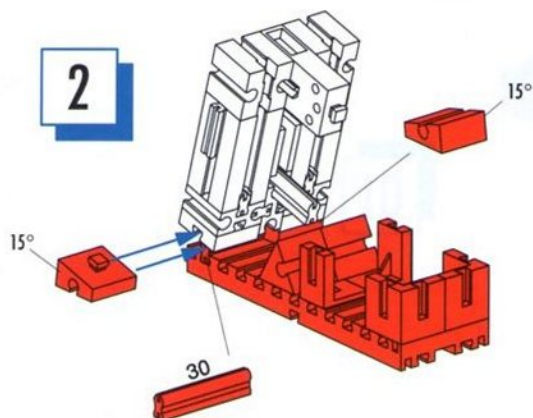

3

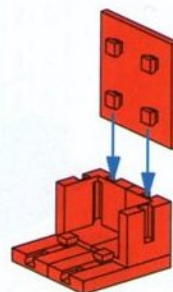

4

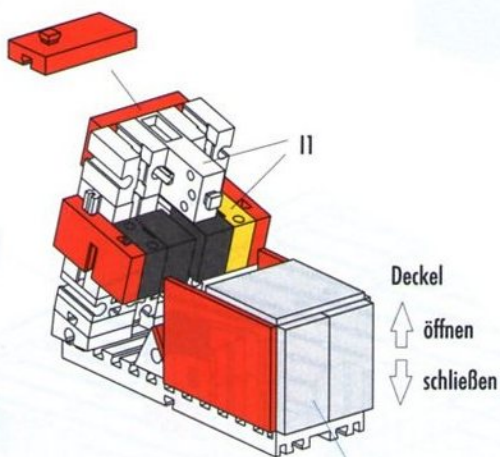

3

Deckel
 ↑ öffnen
 ↓ schließen

5

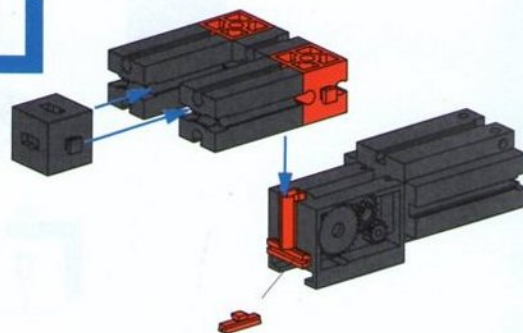

6

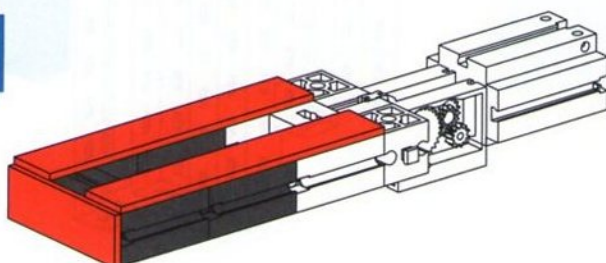

7

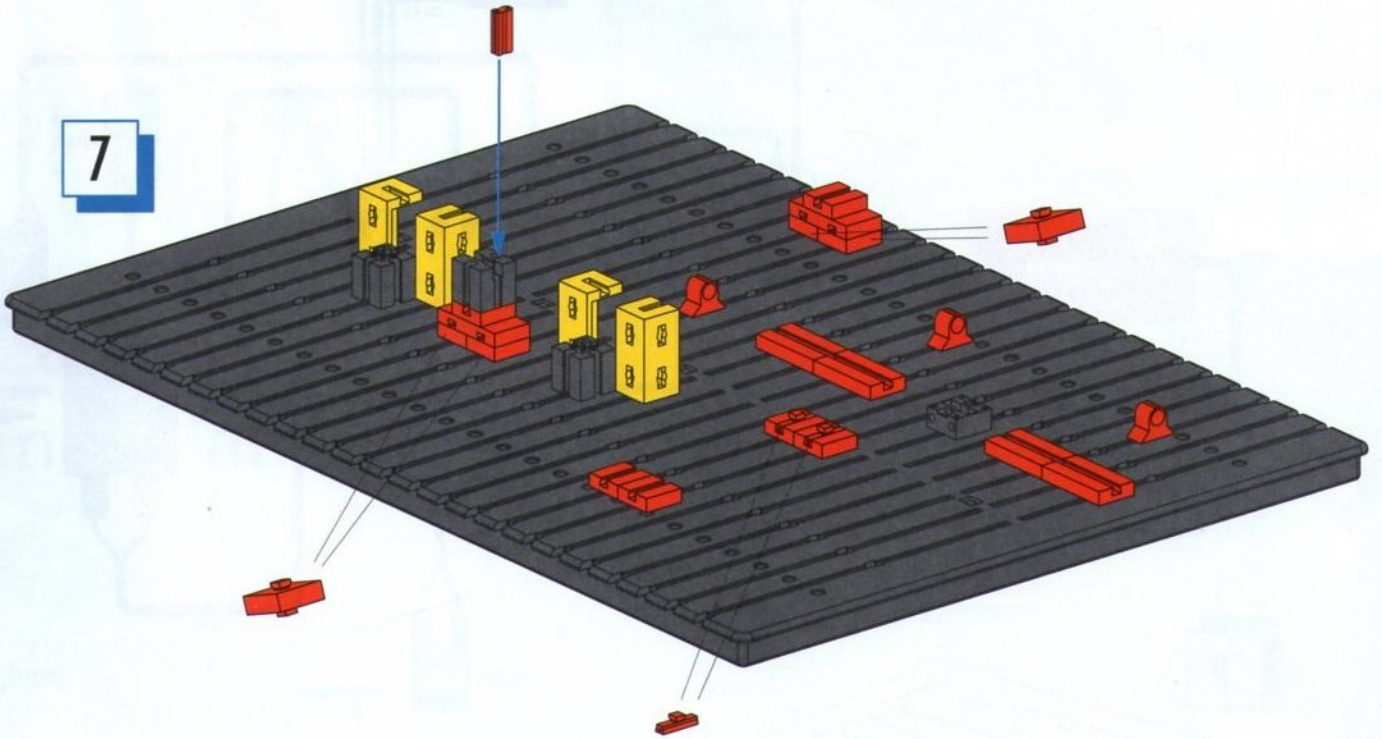

8

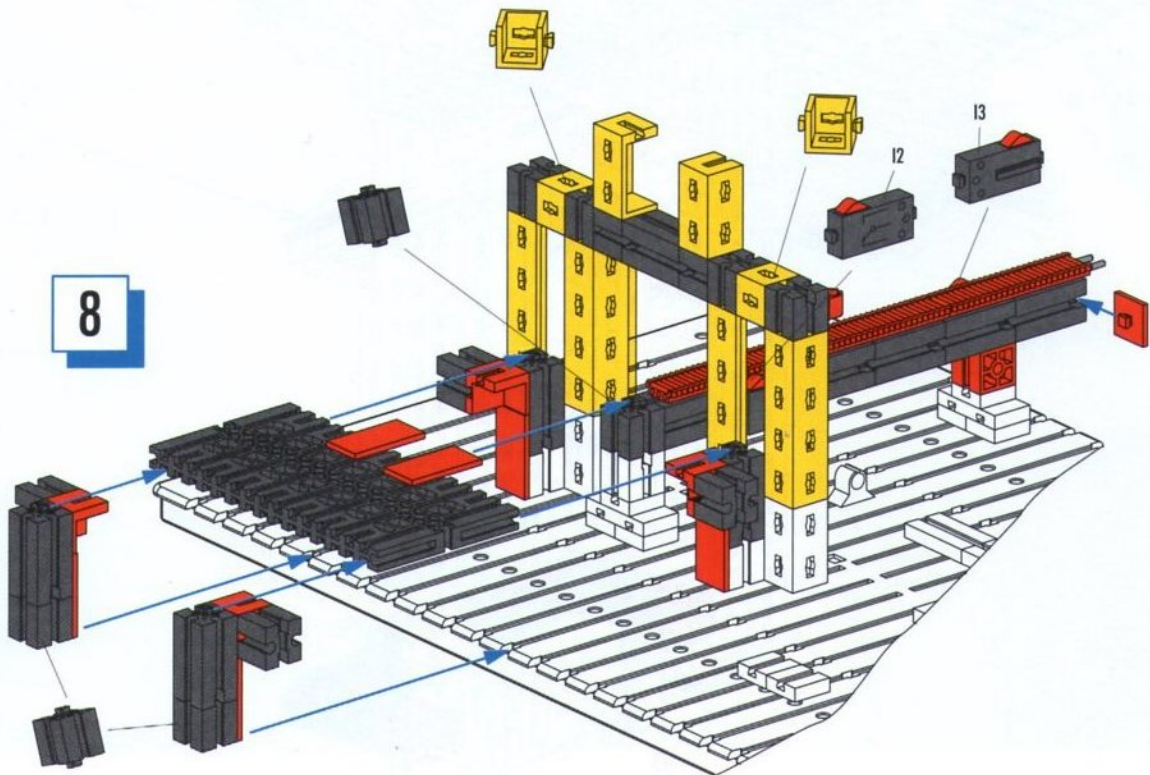

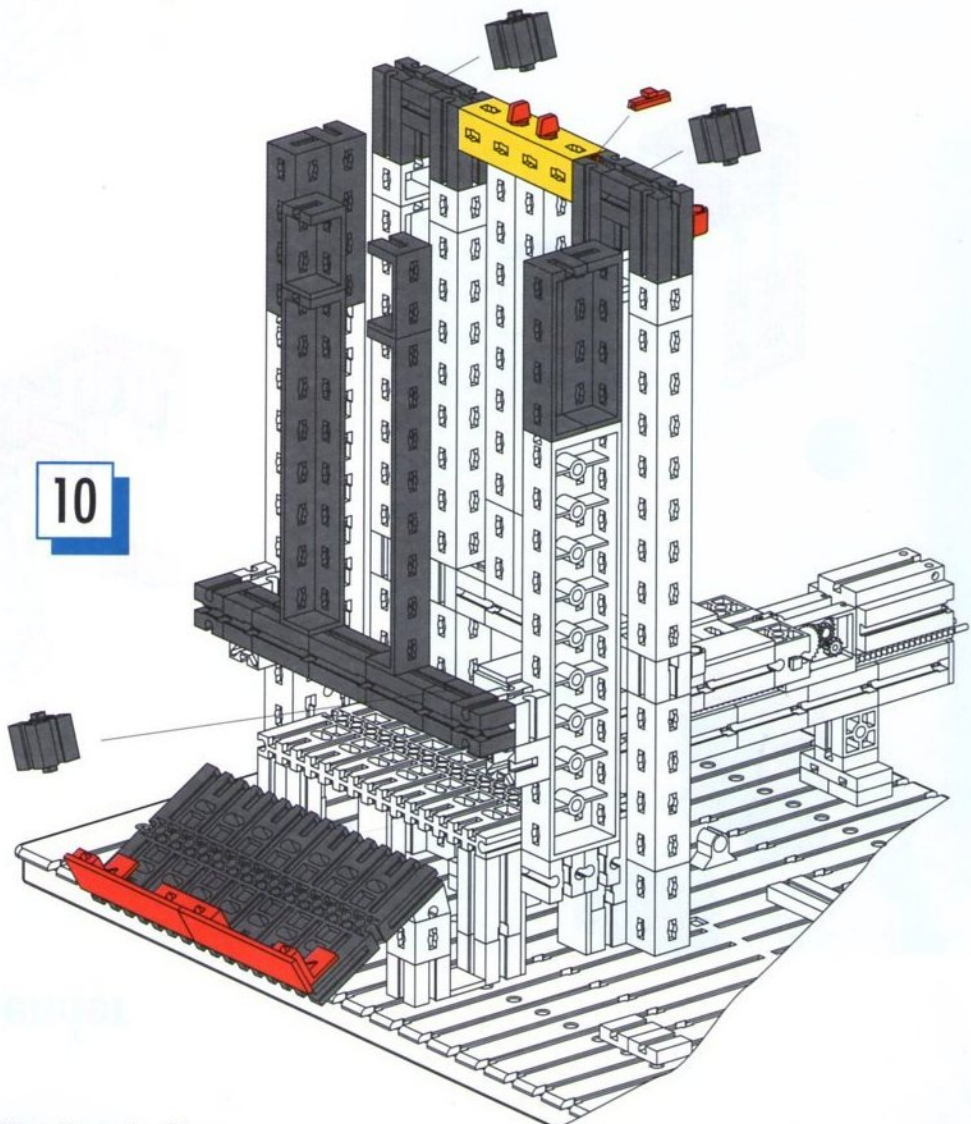
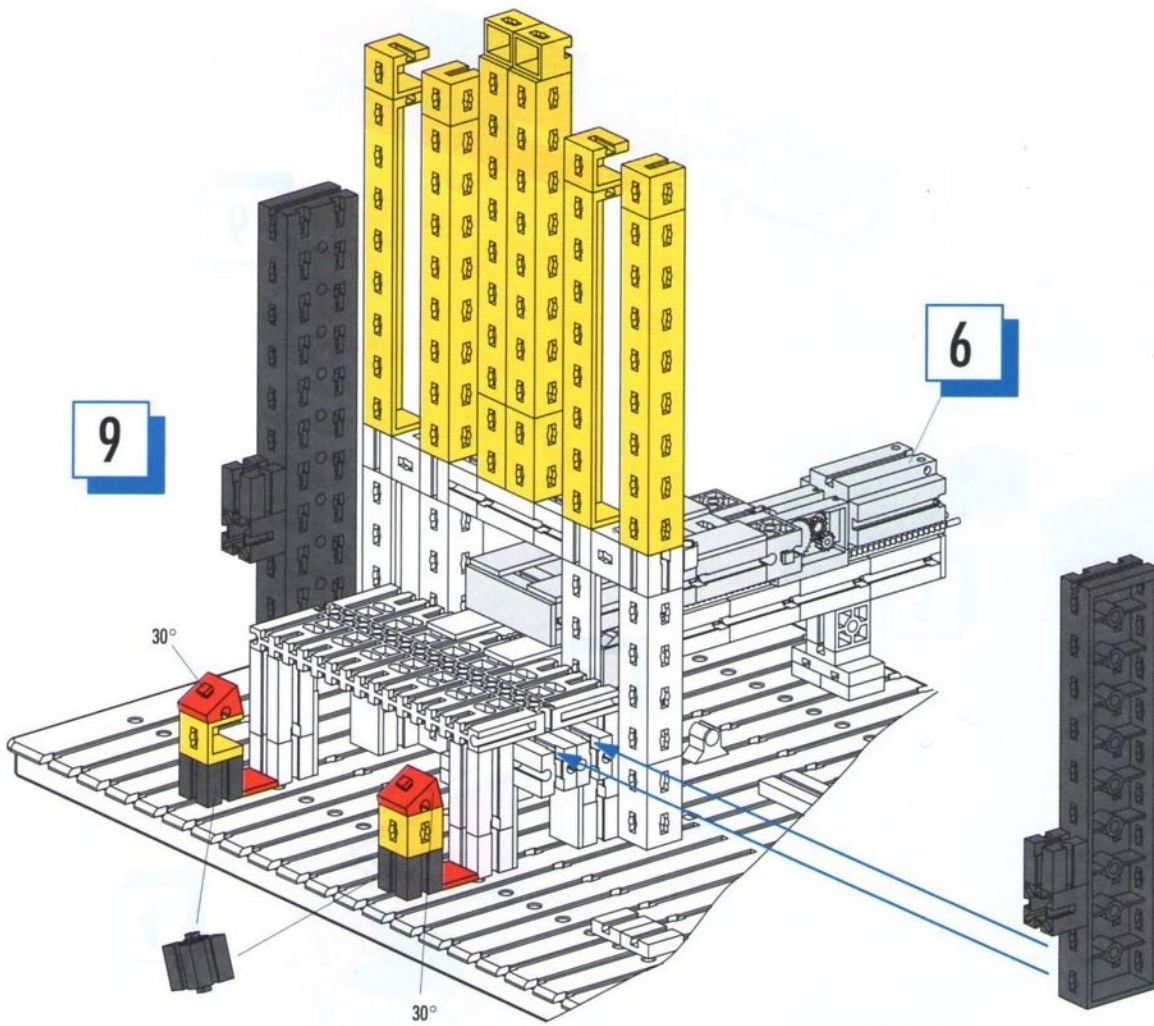

Betriebsanzeige

Motor

I3

I2

11

4

Schaltplan

